

PLM350T/PLI350T

PLM350T

PLI350T

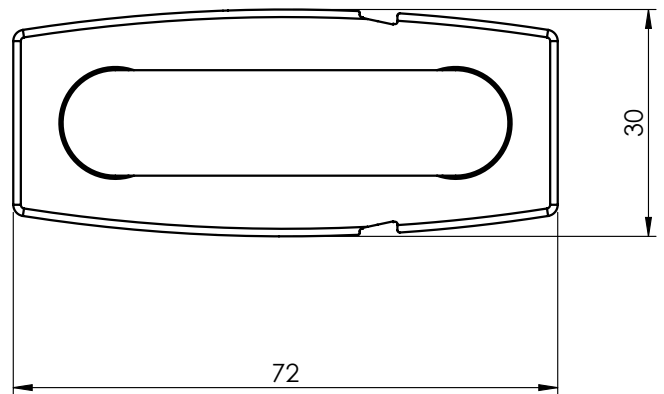
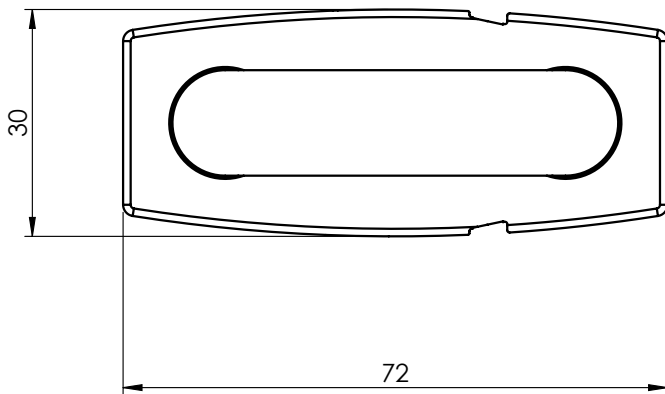
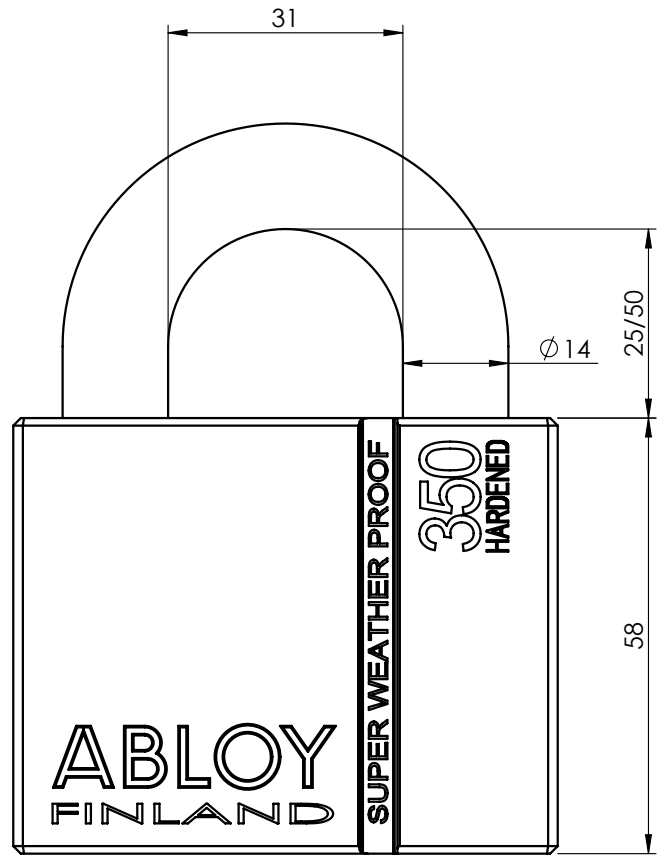
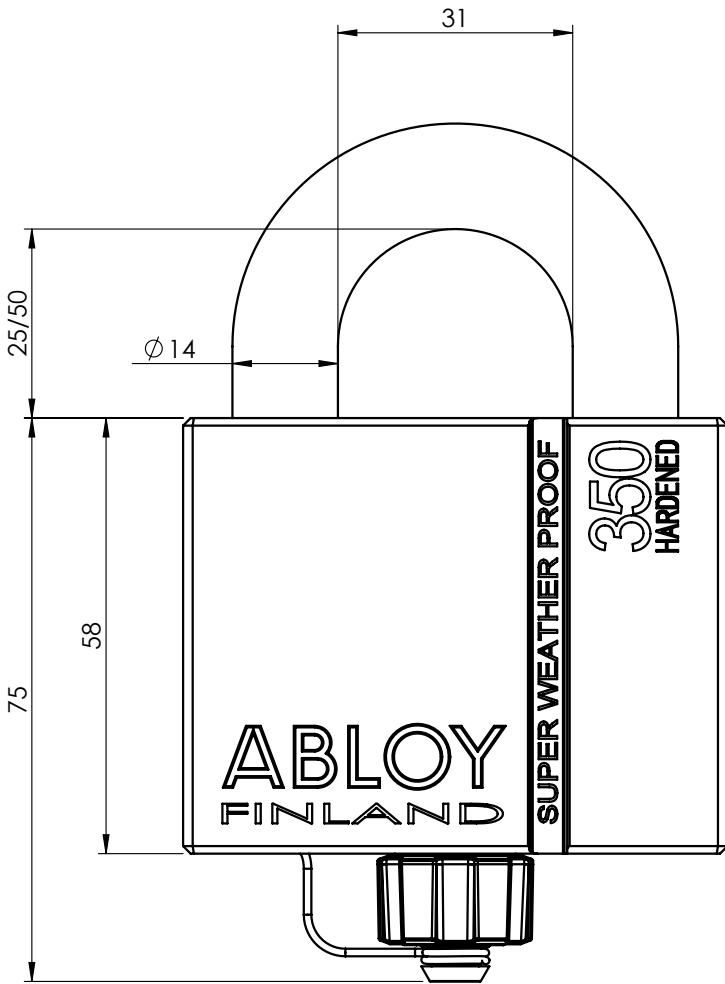

Copyright © Abloy Oy Joensuu Factory 2014

Valid from: dd.mm.yyyy

Drawn	Country	Drawing Number	rev.	Date
TOMIS		DM-01037	B	30.04.15